

Femoral Impactor – Technical Guide



# Contents

Overview.....	1
Components & Features.....	2
Assembly Instructions.....	3
Impaction.....	7
Disassembly Instructions.....	8
Catalogue.....	10
Nota Bene.....	11

# Overview

The Enztec Femoral Impactor provides a reliable, stable grip of implants and control of impaction loads to ensure correct placement of femoral components.

A range of standard arm tips are available to ensure a secure hold of femoral components.



# Components & Features

The Enztec Femoral Impactor consists of two components; the Handle Assembly and the Impaction Head.

The Handle Assembly comprises the Handle, Arms, Arm Carrier and Head Carrier. These components can not be disassembled from the Handle Assembly, however the Impaction Head can be disassembled from the Handle Assembly for cleaning.

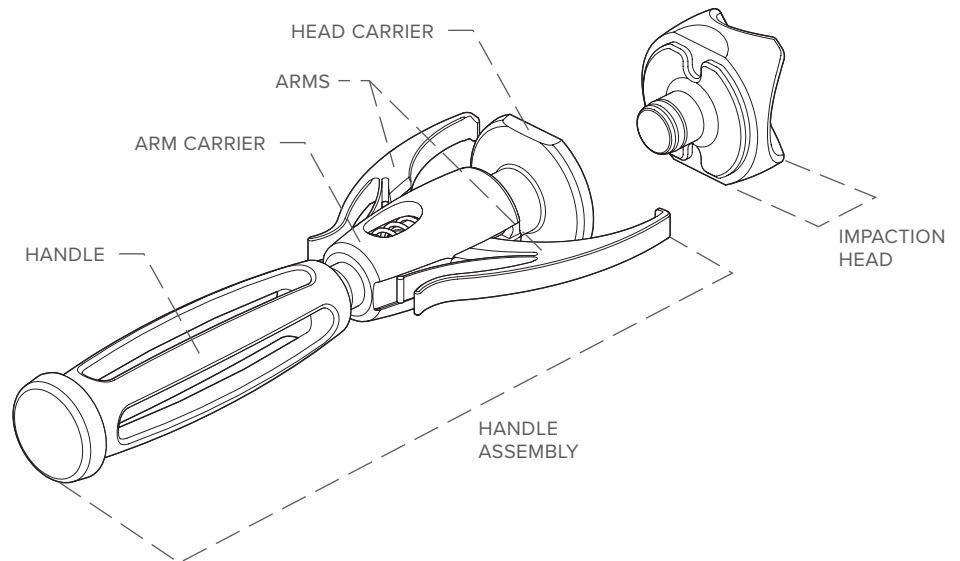

# Assembly – Step One

## Attach Impaction Head

Press the Arms toward each other, allowing the tips of the Arms to splay.

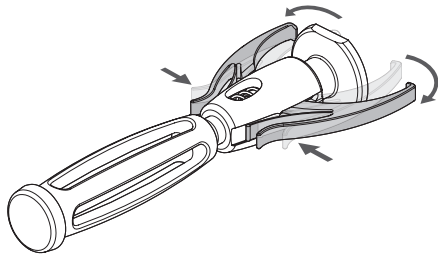

Push the Impaction Head into the Head Carrier.

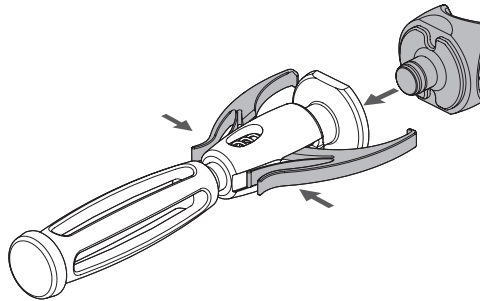

Release the Arms.

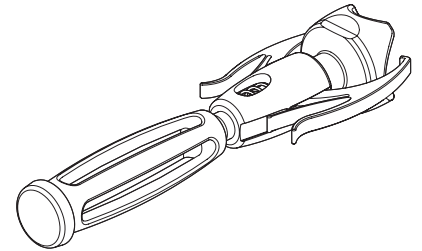

Visually check for any gaps between the Impaction Head and the Head Carrier to ensure the Impaction Head is fully seated.

# Assembly – Step Two

## Position Handle to accept Femoral Component

Rotate the Handle anticlockwise to move the Handle away from the Arm Carrier.

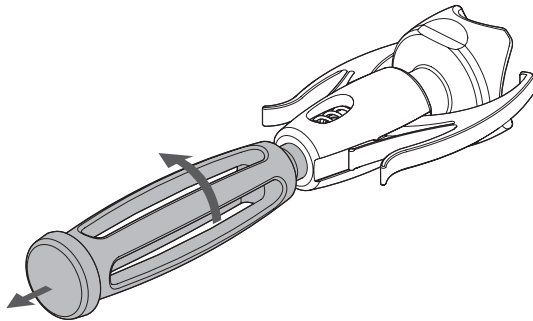

This allows vertical movement of the Head Carrier which enables Femoral Components to be fitted.

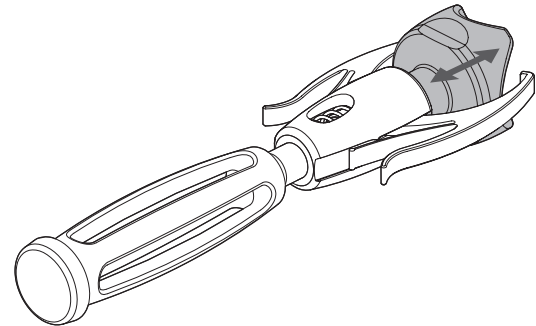

# Assembly – Step Three

## Attach Femoral Component

Press the Arms towards each other allowing the tips of the Arms to splay.

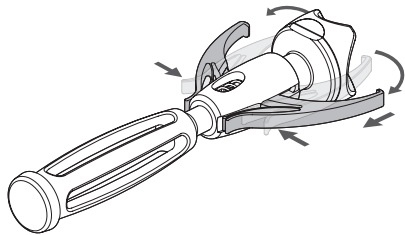

Press the condyle surfaces of the Femoral Component into contact with the Impaction Head.

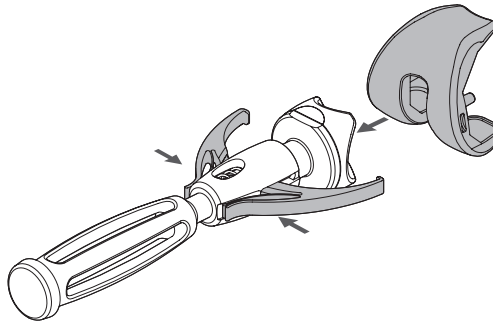

Release the Arms ensuring the tips of the Arms locate within the pockets of the Femoral Component.

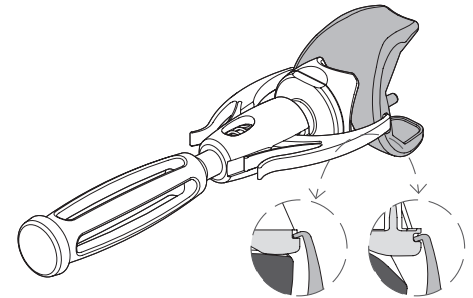

Visually check the Arms are located correctly within the Femoral Component as illustrated in the shown details. Pocket position may differ depending on implant design.

# Assembly – Step Four

## Secure Femoral Component

Rotate the Handle in a clockwise direction until the Handle is firmly hand tightened. This prevents movement of the Head Carrier, locking the Femoral Component in place.

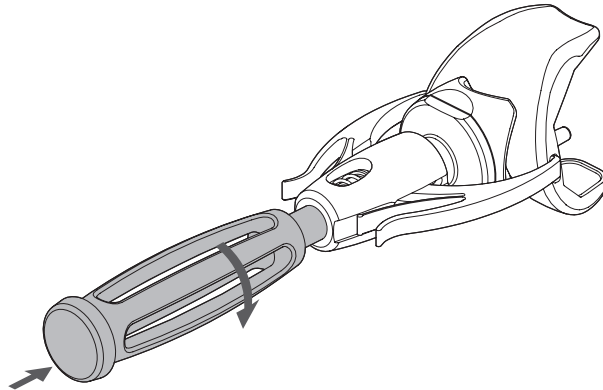

The Femoral Component can then be positioned and impacted onto the distal femur.

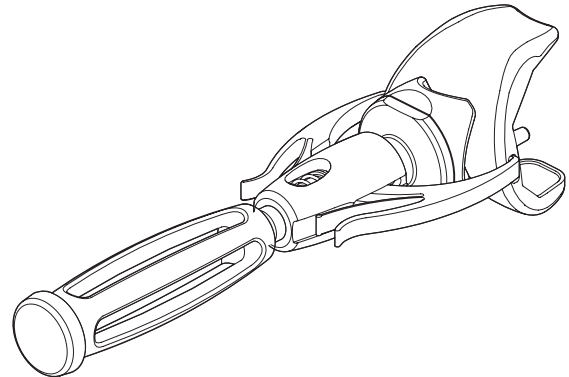



# Impaction

## Impact Femoral Component

Position the component onto the distal femur and impact the anvil of the Femoral Impactor to seat the implant.

Impaction forces should be delivered to the anvil in-line with the axis of the instrument/implant.

**Warning:** Do not attempt to medialise or lateralise the implant by impacting on the Arms of the Femoral Impactor or by impacting sideways on the Handle.

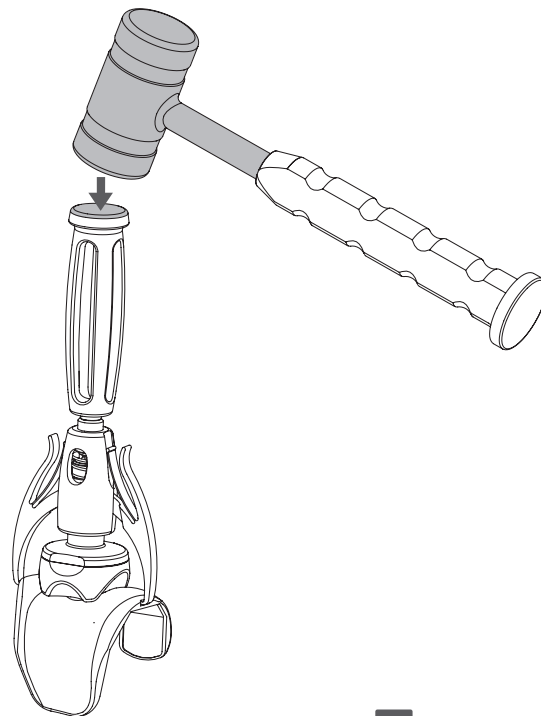
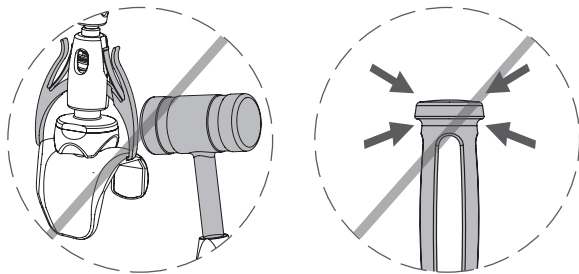

# Disassembly – Step One

## Release Femoral Components

Rotate the Handle in an anticlockwise direction.

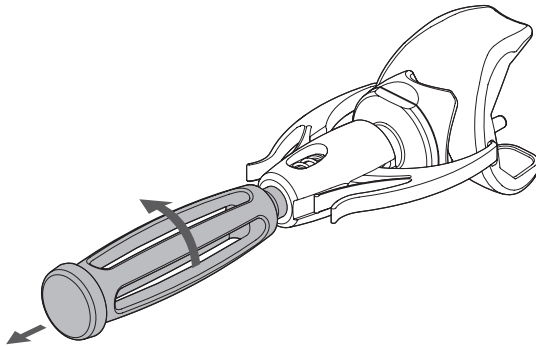

Push the Arms towards each other to release the tips from the Femoral Component.

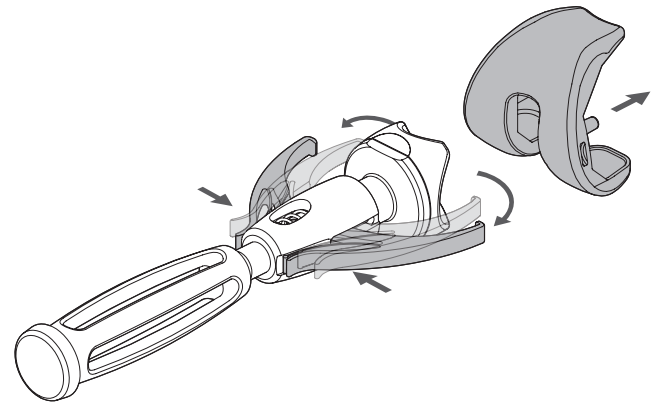

# Disassembly – Step Two

## Remove Impaction Head

Press the Arms towards each other allowing the tips of the Arms to splay.

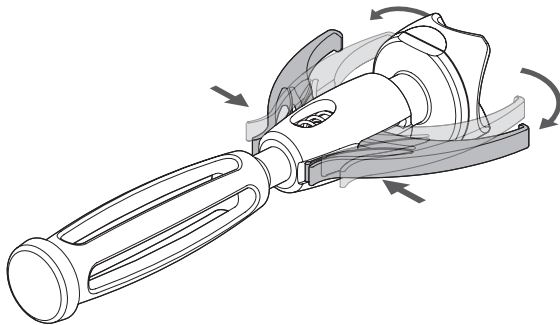

Pull the Impaction Head away from the Head Carrier then release the Arms.

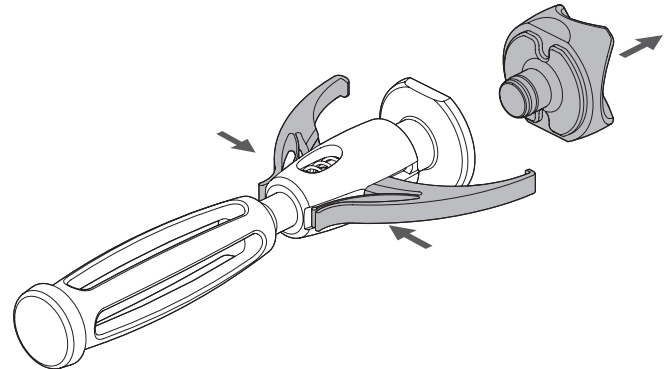

## Femoral Impactor

4240-3060	Enztec Femoral Impactor – Assembly
-----------	---------------------------------------

## Replacement Parts

4240-3061	Enztec Femoral Impactor – Head
-----------	-----------------------------------



## Nota Bene

---

A surgeon must always rely on his or her own professional clinical judgment when deciding which products and/or techniques to use on individual patients. Enztec is not dispensing medical advice and recommends that surgeons be trained in orthopaedic surgeries before performing surgeries.

The information presented is intended to demonstrate the breadth of Enztec product offerings. Always refer to the package insert, product label and/or user instructions before using any Enztec product. Products may not be available in all markets. Product availability is subject to the regulatory or medical practices that govern individual markets. Please contact your Enztec representative if you have any questions about the availability of Enztec products in your area.

Enztec own, use or have applied for the following trademarks or service marks: Enztec.

Patent: US 8277460 B2



Enztec Limited  
3/17 Print Place  
Middleton  
Christchurch, 8024  
New Zealand

© 2021 Enztec Limited  
All rights reserved.

**Contact:**

Enztec Limited  
P.O.Box 31029, Ilam  
Christchurch, 8444  
New Zealand  
Ph: + 64 3 348 0203  
W: [www.enztec.com](http://www.enztec.com)

**Part No: 11627-00; Rev: 5**

